



**Technical and Test Institute
for Construction Prague**
Prosecká 811/76a
190 00 Prague
Czech Republic
eota@tzus.cz



Member of



www.eota.eu

European Technical Assessment

ETA 22/0892 of 09/01/2023

Technical Assessment Body issuing the ETA: Technical and Test Institute
for Construction Prague

Trade name of the construction product

Sika AnchorFix[®]-2020
Sika AnchorFix[®]-2020 Arctic
Sika AnchorFix[®]-2020 Tropical
for rebar connection

**Product family to which the construction
product belongs**

Product area code: 33
Post installed rebar connections
with Sika AnchorFix[®]-2020, Sika
AnchorFix[®]-2020 Arctic, Sika AnchorFix[®]-
2020 Tropical injection mortar

Manufacturer

Sika Services AG,
Tueffenwies 16,
CH-8048 Zuerich,
Switzerland

Manufacturing plant

Sika Plant No. 503 44 08 (1138)

**This European Technical Assessment
contains**

17 pages including 14 Annexes which form
an integral part of this assessment.

**This European Technical Assessment is
issued in accordance with regulation
(EU) No 305/2011, on the basis of**

EAD 330087-01-0601
Systems for post-installed rebar
connections with mortar

Translations of this European Technical Assessment in other languages shall fully correspond to the original issued document and should be identified as such.

Communication of this European Technical Assessment, including transmission by electronic means, shall be in full (excepted the confidential Annex(es) referred to above). However, partial reproduction may be made, with the written consent of the issuing Technical Assessment Body - Technical and Test Institute for Construction Prague. Any partial reproduction has to be identified as such.

1. Technical description of the product

The Sika AnchorFix®-2020, Sika AnchorFix®-2020 Arctic (faster curing time) and Sika AnchorFix®-2020 Tropical (extended processing time) injection system is used for the connection, by anchoring or overlap joint, of reinforcing bars (rebars) in existing structures made of normal weight concrete. The design of the post-installed rebar connections is done in accordance with the regulations for reinforced concrete constructions.

Reinforcing bars made of steel with a diameter d from 8 to 32 mm and Sika AnchorFix®-2020, Sika AnchorFix®-2020 Arctic, Sika AnchorFix®-2020 Tropical chemical mortar are used for rebar connections. The steel element is placed into a drilled hole filled with injection mortar and is anchored via the bond between embedded element, injection mortar and concrete.

The illustration and the description of the product are given in Annex A.

2. Specification of the intended use in accordance with the applicable EAD

The performances given in Section 3 are only valid if the anchor is used in compliance with the specifications and conditions given in Annex B.

The provisions made in this European Technical Assessment are based on an assumed working life of the anchor of 50 years and 100 years. The indications given on the working life cannot be interpreted as a guarantee given by the producer, but are to be regarded only as a means for choosing the products in relation to the expected economically reasonable working life of the works.

3. Performance of the product and references to the methods used for its assessment

3.1 Mechanical resistance and stability (BWR 1)

Essential characteristic	Performance
Bond strength of post-installed rebar	See Annex C 1
Reduction factor	See Annex C 1
Amplification factor for minimum anchorage length	See Annex C 1

3.2 Safety in case of fire (BWR 2)

Essential characteristic	Performance
Reaction to fire	Class (A1) according to EN 13501-1
Resistance to fire	See Annex C 2

3.3 General aspects relating to fitness for use

Durability and serviceability are only ensured if the specifications of intended use according to Annex B 1 are kept.

4. Assessment and verification of constancy of performance (AVCP) system applied with reference to its legal base

According to the Decision 96/582/EC of the European Commission¹ the system of assessment verification of constancy of performance (see Annex V to Regulation (EU) No 305/2011) given in the following table apply.

Product	Intended use	Level or class	System
Metal anchors for use in concrete	For fixing and/or supporting concrete structural elements or heavy units such as cladding and suspended ceilings	-	1

¹ Official Journal of the European Communities L 254 of 08.10.1996

5. Technical details necessary for the implementation of the AVCP system, as provided in the applicable EAD

The factory production control shall be in accordance with the control plan which is a part of the technical documentation of this European Technical Assessment. The control plan is laid down in the context of the factory production control system operated by the manufacturer and deposited at Technical and Test Institute for Construction Prague.² The results of factory production control shall be recorded and evaluated in accordance with the provisions of the control plan.

Issued in Prague on 09.01.2023

By

Ing. Jiří Studnička, Ph.D.
Head of the Technical Assessment Body



² The control plan is a confidential part of the documentation of the European Technical Assessment, but not published together with the ETA and only handed over to the approved body involved in the procedure of AVCP.

Figure A1: Overlap joint for rebar connections of slabs and beams

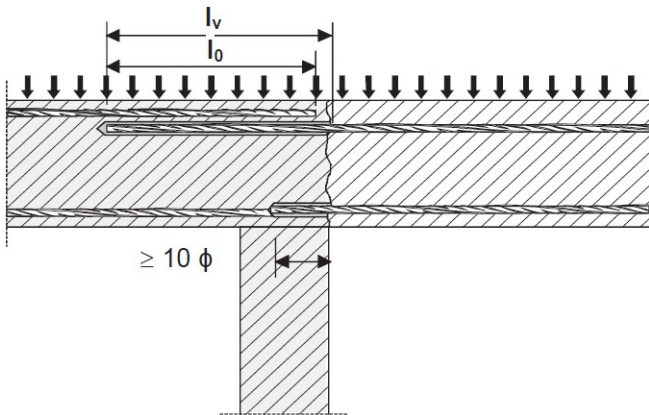

Figure A2: Overlap joint at a foundation of a column or wall where the rebar is stressed in tension

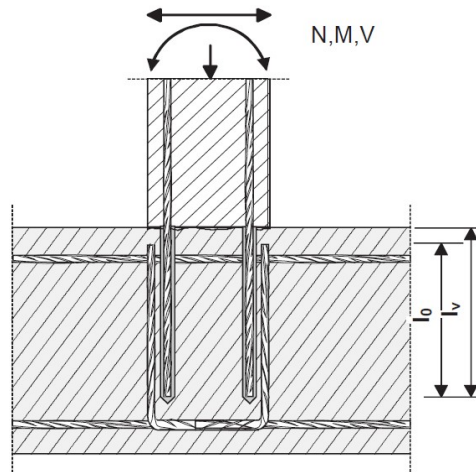

Figure A3: End anchoring of slabs or beams, designed as simply supported

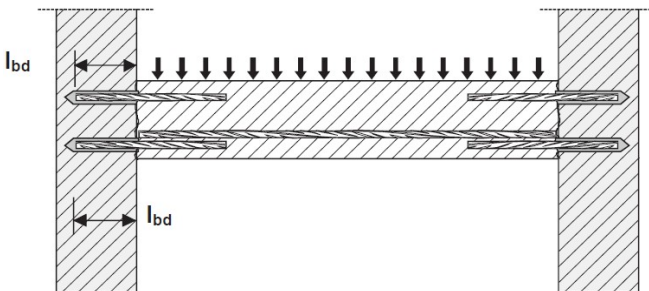

Figure A4: Rebar connection for components stressed primarily in compression. The rebar is stressed in compression.

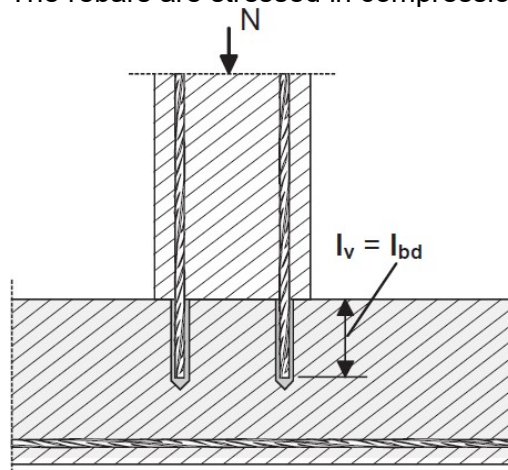
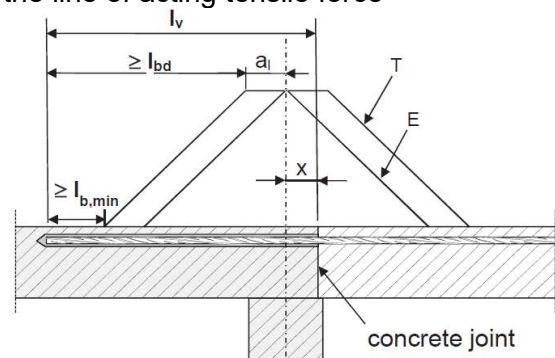

Figure A5: Anchoring of reinforcement to cover the line of acting tensile force



(only post-installed rebar is plotted)

Key to Figure A5

- T acting tensile force
- E envelope of $M_{ed}/z + N_{ed}$ (see EN 1992-1-1, Figure 9.2)
- x distance between the theoretical point of support and concrete joint

Note to Figure A1 to A5:

In the Figures no transverse reinforcement is plotted, the transverse reinforcement as required by EN 1992-1-1 shall be present.

The shear transfer between old and new concrete shall be designed according to EN 1992-1-1.

Sika AnchorFix®-2020, Sika AnchorFix®-2020 Arctic, Sika AnchorFix®-2020 Tropical

Product description
Installed condition and examples of use for rebars

Annex A 1

Coaxial cartridge

Sika AnchorFix®-2020, Arctic, Tropical
150 ml
380 ml
400 ml
410 ml

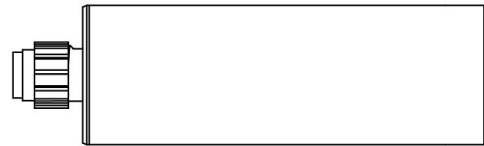

Side by side cartridge

Sika AnchorFix®-2020, Arctic, Tropical
350 ml
825 ml

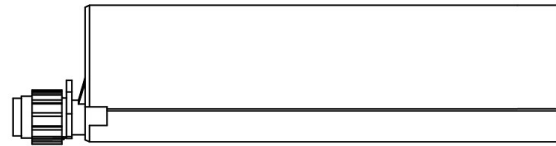

Two part foil in a single piston component cartridge

Sika AnchorFix®-2020, Arctic, Tropical
150 ml
170 ml
300 ml
550 ml
850 ml

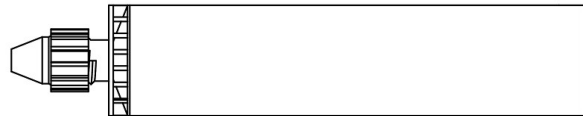

Peeler cartridge

Sika AnchorFix®-2020, Arctic, Tropical
280 ml

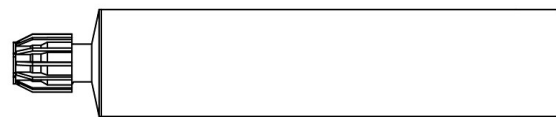

Marking of the mortar cartridges

Identifying mark of the producer, Trade name, Charge code number, Storage life, Curing and processing time

Mixing nozzle

KW

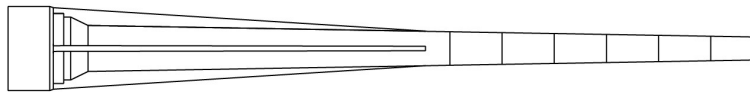

RC

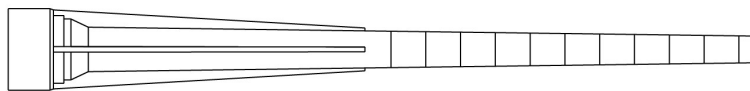

EZ



RM

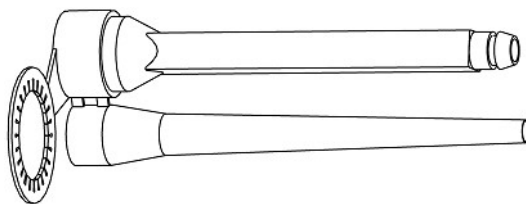

TB

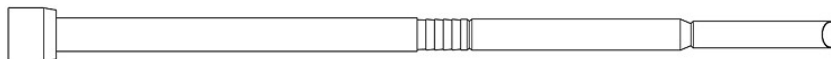

KR for 850

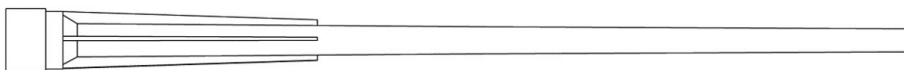

Sika AnchorFix®-2020, Sika AnchorFix®-2020 Arctic,
Sika AnchorFix®-2020 Tropical

Product description
Injection system

Annex A 2

Rebar Ø8, Ø10, Ø12, Ø14, Ø16, Ø20, Ø24, Ø25, Ø26, Ø28, Ø32

Figure A6: Reinforcing bar



Minimum value of related rib area $f_{R,min}$ according to EN 1992-1-1:2004.

- The maximum outer rebar diameter over the ribs shall be:
Nominal diameter of the rib $d + 2 \cdot h$ ($h \leq 0,07 \cdot d$)
(d: nominal diameter of the bar; h: rib height of the bar)

Table A1: Materials

Product form		Bars and de-coiled rods	
Class		B	C
Characteristic yield strength f_{yk} or $f_{0,2k}$ (MPa)		400 to 600	
Minimum value of $k = (f_t / f_y)_k$		$\geq 1,08$	$\geq 1,15$ < 1,35
Characteristic strain at maximum force ϵ_{uk} (%)		$\geq 5,0$	$\geq 7,5$
Bendability		Bend / Rebend test	
Maximum deviation from nominal mass (individual bar) (%)	Nominal bar size (mm) ≤ 8	$\pm 6,0$	
	> 8	$\pm 4,5$	
Bond: Minimum relative rib area, $f_{R,min}$	Nominal bar size (mm) 8 to 12	0,040	
	> 12	0,056	

Sika AnchorFix®-2020, Sika AnchorFix®-2020 Arctic, Sika AnchorFix®-2020 Tropical

Product description
Rebar and materials

Annex A 3

Specifications of intended use

Anchorage subject to:

- Static and quasi-static load.

Base materials

- Reinforced or unreinforced normal weight concrete according to EN 206:2013
- Strength classes C12/15 to C50/60 according to EN 206:2013.
- Maximum chloride concrete of 0,40% (CL 0.40) related to the cement content according to EN 206:2013.
- Non-carbonated concrete.

Note: In case of a carbonated surface of the existing concrete structure the carbonated layer shall be removed in the area of the post installed rebar connection (with a diameter $d_s + 60$ mm) prior to the installation of the new rebar. The depth of concrete to be removed shall correspond to at least minimum concrete cover in accordance with EN 1992-1-1.

The foregoing may be neglected if building components are new and not carbonated.

Temperature range:

- -40°C to $+80^{\circ}\text{C}$ (max. short. term temperature $+80^{\circ}\text{C}$ and max. long term temperature $+50^{\circ}\text{C}$)

Use conditions (Environmental conditions)

- The rebars may be used in dry or wet concrete.

Design:

- The anchorages are designed under the responsibility of an engineer experienced in anchorages and concrete work.
- Verifiable calculation notes and drawings are prepared taking account of the forces to be transmitted.
- Design according to EN 1992-1-1 and EN 1992-1-2.
- The position of the reinforcement in the existing structure shall be determined on the basis of the construction documentation and taken into account when designing.

Installation:

- Dry or wet concrete.
- It must not be installed in flooded holes.
- Hole drilling by hammer drill or compressed air drill mode.
- The installation of post-installed rebars shall be done only by suitable trained installer and under supervision on site. The conditions under which an installer may be considered as suitable trained and the conditions for supervision on site are up to the Member States in which the installation is done.
- Check the position of the existing rebars (if the position is not known, it shall be determined using a rebar detector suitable for this purpose)

Sika AnchorFix®-2020, Sika AnchorFix®-2020 Arctic,
Sika AnchorFix®-2020 Tropical

Intended use
Specifications

Annex B 1

Figure B1: General design rules of construction for bonded-in rebars

- Only tension forces in the axis of the rebar may be transmitted
- The transfer of shear forces between new concrete and existing structure shall be designed additionally according to EN 1992-1-1.
- The joints for concreting must be roughened to at least such an extent that aggregate protrude.

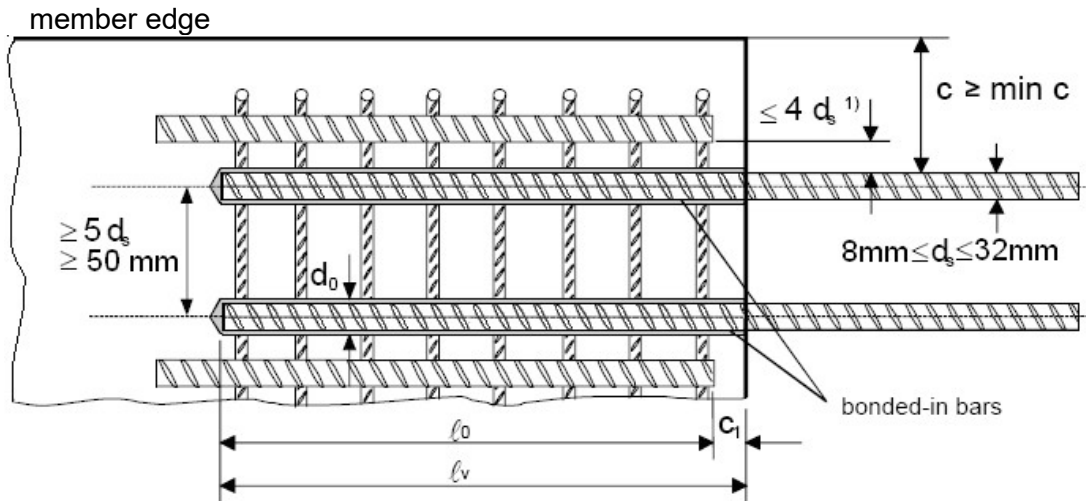

1) If the clear distance between lapped bars exceeds $4d_s$ then the lap length shall be increased by the difference between the clear bar distance and $4d_s$

- c concrete cover of bonded-in bar
- c_1 concrete cover at end-face of bonded-in bar
- min c minimum concrete cover acc. Table B1 of this assessment
- d_s diameter of bonded-in bar
- ℓ_0 lap length acc. to EN 1992-1-1:2004
- ℓ_v effective embedment depth $\geq \ell_0 + c_1$
- d_0 nominal drill bit diameter, see Table B3

**Sika AnchorFix®-2020, Sika AnchorFix®-2020 Arctic,
Sika AnchorFix®-2020 Tropical**

Intended use
General design rules of construction

Annex B 2

Table B1: Minimum concrete cover c_{min} depending on drilling method

Drilling method	Bar diameter ϕ	Without drilling aid	With drilling aid
		c_{min}	c_{min}
Hammer drilling	< 25 mm	30 mm + 0,06 $l_v \geq 2 \phi$	30 mm + 0,02 $l_v \geq 2 \phi$
	≥ 25 mm	40 mm + 0,06 $l_v \geq 2 \phi$	40 mm + 0,02 $l_v \geq 2 \phi$
Compressed air drilling	< 25 mm	50 mm + 0,08 l_v	50 mm + 0,02 l_v
	≥ 25 mm	60 mm + 0,08 $l_v \geq 2 \phi$	60 mm + 0,02 $l_v \geq 2 \phi$

Figure B2: Example of drilling aid

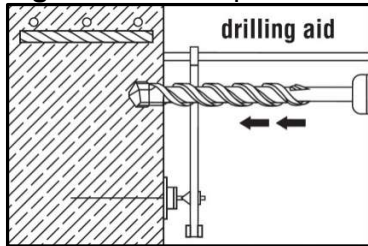

Minimum anchorage length $l_{bd,PIR}$ and minimum anchorage lap length $l_{0,PIR}$

Minimum anchorage length

$$l_{bd,PIR} = \alpha_{ib} \cdot l_{b,min}$$

$\alpha_{ib} = \alpha_{ib,100y}$ = amplification factor for minimum anchorage length
(see Annex C 1, Table C2 for hammer drilling method)

$l_{b,min}$ = minimum anchorage length of cast-in rebar according to EN 1992-1-1, eq. 8.6

Minimum lap length

$$l_{0,PIR} = \alpha_{ib} \cdot l_{0,min}$$

$\alpha_{ib} = \alpha_{ib,100y}$ = amplification factor for minimum anchorage length
(see Annex C 1, Table C2 for hammer drilling method)

$l_{0,min}$ = minimum lap length of cast-in rebar according to EN 1992-1-1, eq. 8.11

Table B2: Drilling diameter and maximum anchorage depth

Rebar diameter $d_{nom}^1)$ [mm]	Nominal drilling diameter d_{cut} [mm]	Max permissible embedment depth $l_{v,max}$ [mm]
8	12 (10)	400
10	14 (12)	500
12	16	600
14	18	700
16	20	800
20	25	1000
24	32	1000
25	32	1000
26	32	1000
28	35	1000
32	40	1000

¹⁾ The maximum outer rebar diameter over the ribs shall be:
nominal diameter of the bar $d_{nom} + 0,20 d_{nom}$

**Sika AnchorFix®-2020, Sika AnchorFix®-2020 Arctic,
Sika AnchorFix®-2020 Tropical**

Intended use
Minimum concrete cover
Minimum anchorage length
Maximum installation length

Annex B 3

Table B3: Processing and Load time

Sika AnchorFix®-2020			
Resin cartridge temperature [°C]	T Work [mins]	Base material Temperature [°C]	T Load [mins]
+10	30 mins	-10 to -5	24 hours
+5	20 mins	-5 to 0	300 mins
0 to +5	15 mins	0 to +5	210 mins
+5 to +10	10 mins	+5 to +10	145 mins
+10 to +15	8 mins	+10 to +15	85 mins
+15 to +20	6 mins	+15 to +20	75 mins
+20 to +25	5 mins	+20 to +25	50 mins
+25 to +30	4 mins	+25 to +30	40 mins

Sika AnchorFix®-2020 Arctic			
Resin cartridge temperature [°C]	T Work [mins]	Base material Temperature [°C]	T Load [mins]
+20	40 mins	-20 to -15	24 hours
+20	30 mins	-15 to -10	18 hours
+5	20 mins	-10 to -5	12 hours
+5	15 mins	-5 to 0	100 mins
0 to +5	10 mins	0 to +5	75 mins
+5 to +20	5 mins	+5 to +20	50 mins
+20	100 second	+20	20 mins

Sika AnchorFix®-2020 Tropical			
Resin cartridge temperature [°C]	T Work [mins]	Base material Temperature [°C]	T Load [mins]
+15 to +20	15 mins	+15 to +20	5 hours
+15 to +25	10 mins	+20 to +25	145 mins
+15 to +30	7.5 mins	+25 to +30	85 mins
+15 to +35	5 mins	+30 to +35	50 mins
+15 to +40	3.5 mins	+35 to +40	40 mins

T work is typical gel time at highest temperature

T load is set at the lowest temperature

**Sika AnchorFix®-2020, Sika AnchorFix®-2020 Arctic,
Sika AnchorFix®-2020 Tropical**

Intended use
Processing and Load time

Annex B 4

Table B4: Applicator gun

Applicator gun	Cartridge	Applicator gun	Cartridge
A 	Coaxial 380ml 400ml 410ml	B 	Side by side 350ml
C 	Foil capsule 150ml 300ml 550ml	D 	Foil capsule 150ml 170ml 300ml Peeler 280ml
E 	Coaxial 150ml	F 	Side by side 825ml
G 	Foil capsule 850ml	H 	Side by side 825ml

Sika AnchorFix®-2020, Sika AnchorFix®-2020 Arctic,
Sika AnchorFix®-2020 Tropical

Intended use
Applicator gun

Annex B 5

Table B5: Brush

Sizes	Ø8	Ø10	Ø12	Ø14	Ø16	Ø20	Ø24	Ø25	Ø26	Ø28	Ø32
Drill hole diameter d_0 [mm]	12(10)	14(12)	16	18	20	25	32	32	32	35	40
Brushes head diameter [mm]	14	14	19	22	22	29	40	40	40	40	42
Brushes head length [mm]	75										

If required use additional accessories and extension for air nozzle and brush to reach back of hole.

Max. hole depth	Brush / extension configuration	Part
250 mm	Standard brush	(a)
550 mm	Brush head unit + handle unit	(b)+(c)
850 mm	Brush head unit + extension piece + handle unit	(b)+(d)+(c)
1150 mm	Brush head unit + 2x extension piece + handle unit	(b)+(d)+(d)+(c)

Part (a)



Part (b)



Part (c)



Part (d)

**Table B6: Extension hose for deep holes**

Sizes	Ø8	Ø10	Ø12	Ø14	Ø16	Ø20	Ø24	Ø25	Ø26	Ø28	Ø32
Hole diameter [mm]	10	12	16	18	20	25	32	32	32	35	40
Extension hose [mm]	9			14							
Resin stopper [mm]	-	-	-	-	18	22	30	30	30	30	36

**Sika AnchorFix®-2020, Sika AnchorFix®-2020 Arctic,
Sika AnchorFix®-2020 Tropical**

Intended use

Brush

Extension hose for deep holes

Annex B 6

Drilling the hole

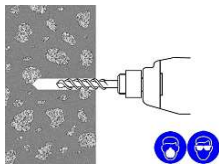

Drill hole to the required embedment depth using a hammer-drill with carbide drill bit set in rotation hammer mode, or a compressed air drill.



Rotary hammer drilling

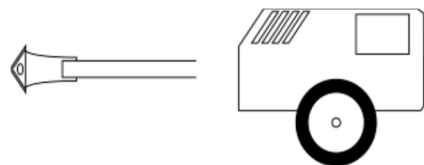

Compressed air drill

Before drilling remove carbonized concrete.

In case of aborted drill hole the drill hole shall be filled with mortar.

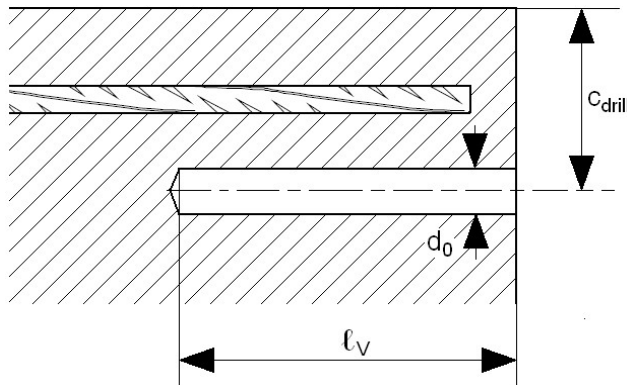

- Observe concrete coverage c , as per setting plan and Table B1
- Drill parallel to the edge and to existing rebar

Cleaning the hole

The borehole must be free of dust, debris, water, ice, oil, grease and other contaminants prior to mortar injection.

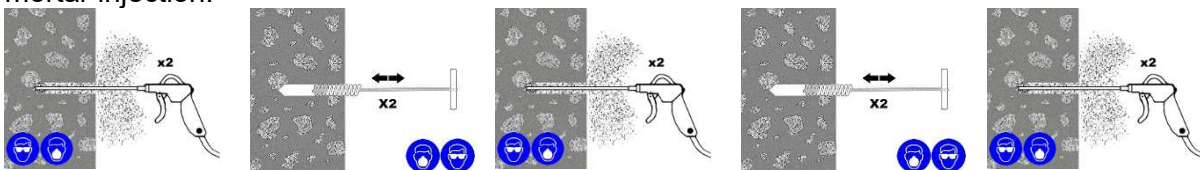

- Blowing 2 time from the back of the hole with oil-free compressed air (min. 6 bar) until return air stream is free of noticed dust.
- Brushing 2 time with the special brush size (brush $\varnothing \geq$ borehole \varnothing) by inserting the brush to the back of the hole in a twisting motion. The brush shall produce natural resistance as it enters the anchor hole. If this is not the case, please use a new brush or a brush with a larger diameter.
- Repeat operation 1 and 2.
- Blowing 1 time again with compressed air until return air stream is free of noticeable dust.

**Sika AnchorFix®-2020, Sika AnchorFix®-2020 Arctic,
Sika AnchorFix®-2020 Tropical**

Intended use
Installation instructions I

Annex B 7

Mortar injection

If the hole collects water after initial cleaning, this water must be removed before injecting the resin.

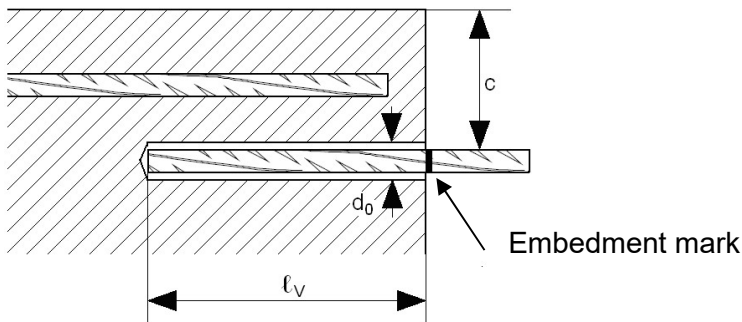

Before use, make sure the rebar is dry and free of oil or other residue.

Mark embedment depth on the rebar (e.g. with tape) l_v

Insert rebar in borehole, to verify hole and setting depth l_v

- Check expiration date: See imprint on cartridge. Do not use an expired product
- Foil pack temperature:
Must be between +5°C and +40°C when in use
- Base material temperature at time of installation:
Must be between +5°C and +40°C
- Instructions for transport and storage:
Keep in a cool, dry and dark place at +5°C to +20°C achieve maximum shelf life

Select the appropriate static mixer nozzle for the installation, open the cartridge/foil and screw onto the mouth of the cartridge. Insert the cartridge into the correct applicator gun.

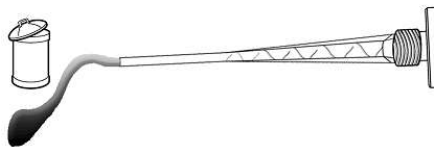

Extrude the first part of the cartridge to waste until an even colour has been achieved without streaking in the resin

If necessary, cut the extension tube to the depth of the hole and push onto the end of the mixer nozzle, and (for rebars 16 mm dia. or more) fit the correct resin stopper to the other end. Attach extension tubing and resin stopper.

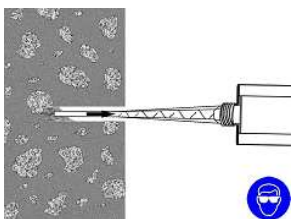

Insert the mixer nozzle (resin stopper / extension tube if applicable) to the bottom of the hole. Begin to extrude the resin and slowly withdraw the mixer nozzle from the hole ensuring that there are no air voids as the mixer nozzle is withdrawn. Fill the hole to approximately $\frac{1}{2}$ to $\frac{3}{4}$ full and remove the mixer nozzle completely.

**Sika AnchorFix®-2020, Sika AnchorFix®-2020 Arctic,
Sika AnchorFix®-2020 Tropical**

Intended use
Installation instructions II

Annex B 8

Inserting the rebar

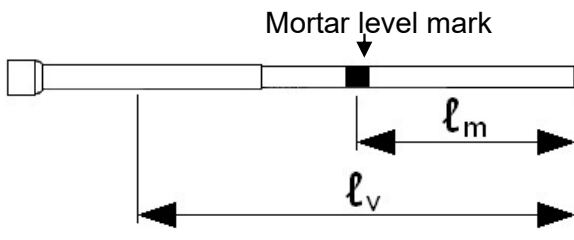

Mark the required mortar level l_m and embedment depth l_v with tape or marker on the injection extension.

Quick estimation: $l_m = 1/2 \cdot l_v$

Continue injection until the mortar level mark l_m becomes visible.

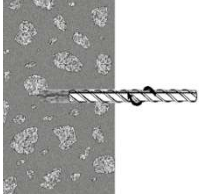

Insert the rebar, free from oil or other release agents, to the bottom of the hole using a back and forth twisting motion ensuring all the threads are thoroughly coated. Adjust to the correct position within the stated working time.

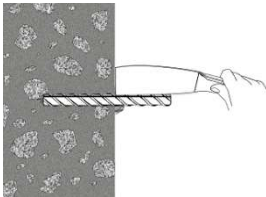

Any excess resin should be expelled from the hole evenly around the steel element showing that the hole is full. This excess resin should be removed from around the mouth of the hole before it sets.

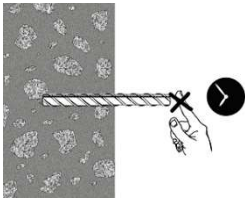

Leave the anchor to cure.

Do not disturb the anchor until the appropriate loading/curing time has elapsed depending on the substrate conditions and ambient temperature.

**Sika AnchorFix®-2020, Sika AnchorFix®-2020 Arctic,
Sika AnchorFix®-2020 Tropical**

Intended use
Installation instructions III

Annex B 9

Design bond strength of post-installed rebar $f_{bd,PIR}$ and $f_{bd,PIR,100y}$ for working life 50 and 100 years

$$f_{bd,PIR} = k_b \cdot f_{bd}$$

k_b = reduction factor

f_{bd} = design bond strength of cast-in rebar according to EN 1992-1-1

Table C1: Values of the design bond strength of post installed rebar $f_{bd,PIR} = f_{bd,PIR,100y}$ with reduction factor $k_b = k_{b,100y}$ for all drilling methods for good bond conditions

Rebar Ø 8 to Ø 16									
Concrete class	C12/15	C16/20	C20/25	C25/30	C30/37	C35/45	C40/50	C45/55	C50/60
k_b [-]	1,0	1,0	1,0	1,0	1,0	1,0	1,0	1,0	1,0
$f_{bd,PIR}$ [N/mm ²]	1,6	2,0	2,3	2,7	3,0	3,4	3,7	4,0	4,3
Rebar Ø 20									
Concrete class	C12/15	C16/20	C20/25	C25/30	C30/37	C35/45	C40/50	C45/55	C50/60
k_b [-]	1,0	1,0	1,0	1,0	1,0	1,0	1,0	0,92	0,86
$f_{bd,PIR}$ [N/mm ²]	1,6	2,0	2,3	2,7	3,0	3,4	3,7		
Rebar Ø 24 to Ø 26									
Concrete class	C12/15	C16/20	C20/25	C25/30	C30/37	C35/45	C40/50	C45/55	C50/60
k_b [-]	1,0	1,0	1,0	1,0	1,0	0,90	0,82	0,76	0,71
$f_{bd,PIR}$ [N/mm ²]	1,6	2,0	2,3	2,7	3,0				
Rebar Ø 28									
Concrete class	C12/15	C16/20	C20/25	C25/30	C30/37	C35/45	C40/50	C45/55	C50/60
k_b [-]	1,0	1,0	1,0	1,0	0,88	0,8	0,73	0,67	0,63
$f_{bd,PIR}$ [N/mm ²]	1,6	2,0	2,3	2,7					
Rebar Ø 32									
Concrete class	C12/15	C16/20	C20/25	C25/30	C30/37	C35/45	C40/50	C45/55	C50/60
k_b [-]	1,0	1,0	1,0	0,86	0,76	0,69	0,63	0,58	0,54
$f_{bd,PIR}$ [N/mm ²]	1,6	2,0	2,3						

Tabulated values are valid for good bond conditions according to EN 1992-1-1.
For all other bond conditions multiply the values by 0,7.

Table C2: Amplification factor for minimum anchorage length

Rebar	Amplification factor	Concrete class								
		C12/15	C16/20	C20/25	C25/30	C30/37	C35/45	C40/50	C45/55	C50/60
Ø 8	$\alpha_{lb} = \alpha_{lb,100y}$	1,0	1,0	1,0	1,0	1,0	1,0	1,0	1,0	1,0
Ø 10		1,0	1,0	1,0	1,0	1,0	1,0	1,0	1,0	1,0
Ø 12		1,0	1,0	1,0	1,0	1,0	1,0	1,0	1,0	1,0
Ø 14		1,0	1,0	1,0	1,0	1,0	1,0	1,0	1,0	1,0
Ø 16		1,0	1,0	1,0	1,0	1,0	1,0	1,0	1,0	1,0
Ø 20		1,0	1,0	1,0	1,0	1,0	1,0	1,0	1,0	1,0
Ø 24		1,0	1,0	1,0	1,0	1,0	1,0	1,0	1,0	1,0
Ø 25		1,0	1,0	1,0	1,0	1,0	1,0	1,0	1,0	1,0
Ø 26		1,0	1,0	1,0	1,0	1,0	1,0	1,0	1,0	1,0
Ø 28		1,0	1,0	1,0	1,0	1,0	1,0	1,0	1,0	1,1
Ø 32		1,0	1,0	1,0	1,0	1,0	1,1	1,2	1,3	1,4

Sika AnchorFix®-2020, Sika AnchorFix®-2020 Arctic,
Sika AnchorFix®-2020 Tropical

Performances
Design values of the ultimate bond strength

Annex C 1

Design values of the bond strength $f_{bk,fi}$ and $f_{bk,fi,100y}$ under fire exposure for working life 50 and 100 years

The design value of the bond strength $f_{bk,fi} = f_{bk,fi,100y}$ under fire exposure has to be calculated according the following equation:

$$f_{bk,fi}(\theta) = f_{bk,fi,100y}(\theta) = k_{fi}(\theta) \cdot f_{bd,PIR} \cdot \frac{\gamma_c}{\gamma_{M,fi}}$$

if: $20^{\circ}\text{C} \leq \theta \leq 68^{\circ}\text{C}$ $k_{fi}(\theta) = 1$
 $> 68^{\circ}\text{C} \leq \theta \leq 325^{\circ}\text{C}$ $k_{fi}(\theta) = 75000 \cdot \theta^{-2,117} / (f_{bd,PIR} \cdot 4,3) \leq 1$
 $\theta > 325^{\circ}\text{C}$ $k_{fi}(\theta) = 0$

with:

- k_{fi} temperature reduction factor
- (θ) temperature in $^{\circ}\text{C}$
- $f_{bd,PIR}$ design value of the bond strength in N/mm^2 according to Table C1 considering the concrete class, the rebar diameter and the bond conditions according to EN 1992-1-1
- γ_c partial safety factor according to EN 1992-1-1
- $\gamma_{M,fi}$ partial safety factor according to EN 1992-1-1

The anchorage length shall be determined in accordance with EN 1992-1-1 equation (8.3) using the bond strength $f_{bk,fi}(\theta)$.

Figure C1: Example of the graph of reduction factor $k_{fi}(\theta)$ for concrete strength class C20/25 for good bond conditions

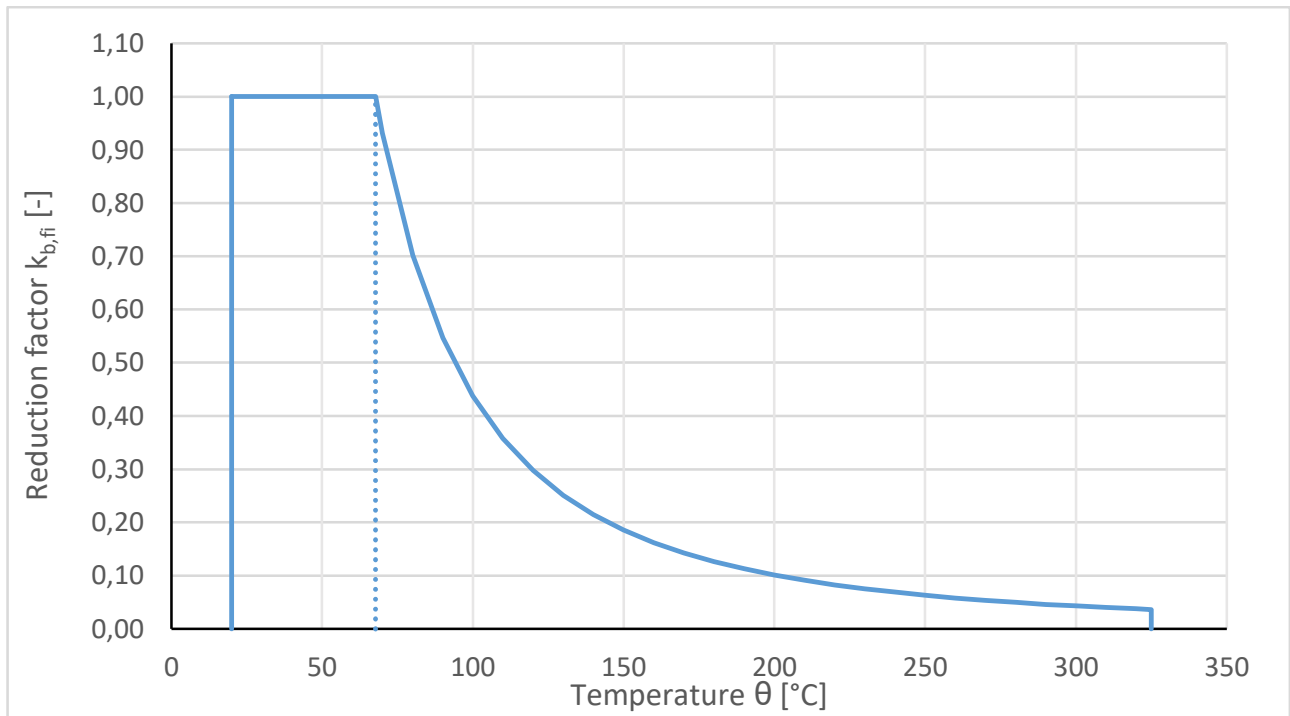

Sika AnchorFix[®]-2020, Sika AnchorFix[®]-2020 Arctic, Sika AnchorFix[®]-2020 Tropical

Performances
Design values of the bond strength under fire exposure

Annex C 2